

FLUSH OPENING LID OPTION (SHOWN)

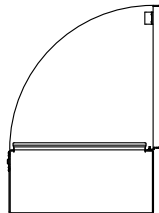

NOT FLUSH OPENING LID OPTION

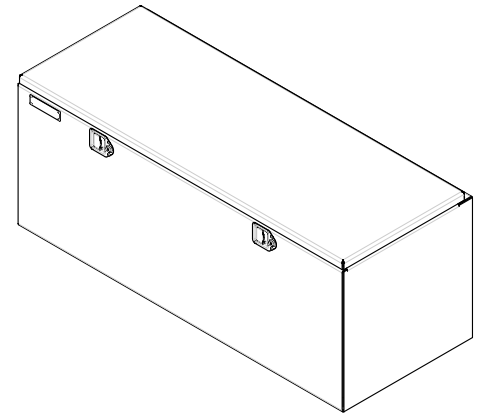

HANDLES ARE LINKED TOGETHER TO ACT IN UNISON

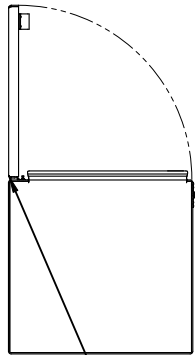
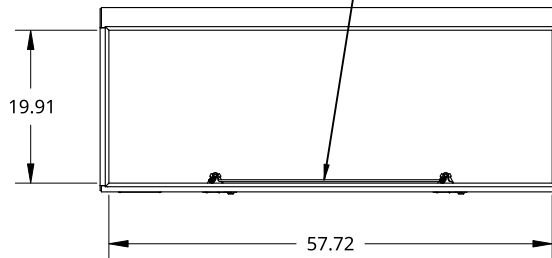

LID IS FLUSH WITH BACK WHEN OPENED TO 90 DEG

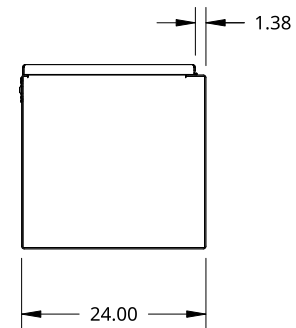
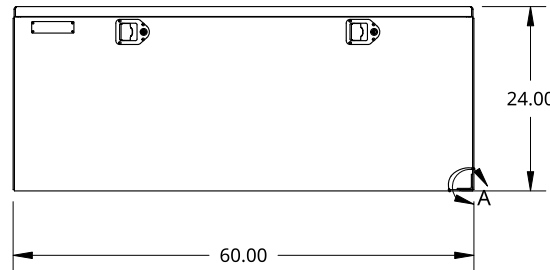

INNER REINFORCEMENT ANGLE BOTH SIDES

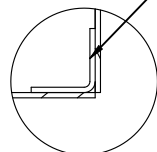

DETAIL A SCALE 1:6

THIS DOCUMENT IS THE PROPERTY OF TREBOR MANUFACTURING. ANY UNAUTHORIZED REPRODUCTION WILL BE PROSECUTED TO THE FULL EXTENT OF THE LAW



PART NO. TRTC2460 REV. B

TOP COVER STYLE TOOL BOX - 24 X 24 X 60 - X2 CLICK HANDLE

UNLESS OTHERWISE SPECIFIED, DIMENSIONS ARE IN INCHES

.XX = ±.1- ANGULAR = ±1°
.XXX = ±.015- FRACTIONAL = ±1/8
.XXXX = ±.005-

DRAWN SHAWN CROCKER 08/01/2021

SIZE A DWG. NO. D9134 REV. B

THIRD ANGLE PROJECTION

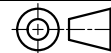

MATERIAL

1/8 ALU CHECKER

SCALE 1:25 WEIGHT 101.82 LB SHEET 1 of 1