

FLUSH OPENING LID OPTION (SHOWN)

NOT FLUSH OPENING LID OPTION

HANDLES ARE LINKED TOGETHER TO ACT IN UNISON

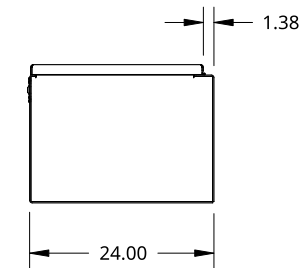
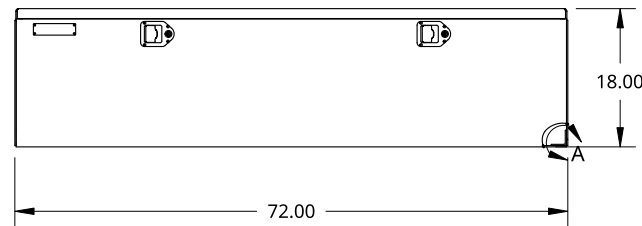
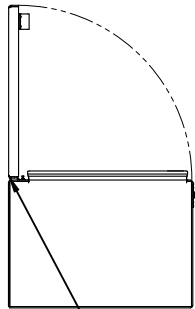
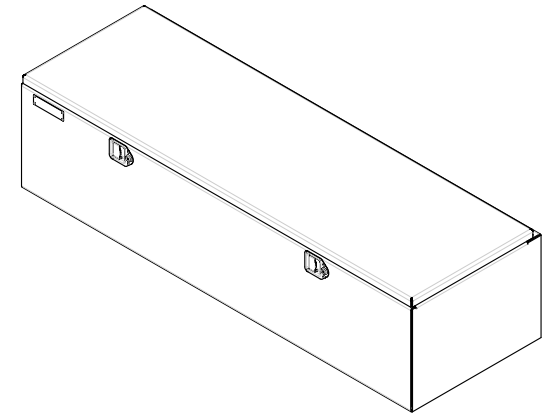
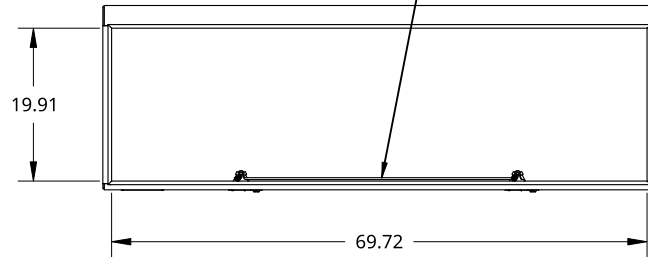

INNER REINFORCEMENT ANGLE BOTH SIDES

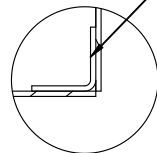

DETAIL A SCALE 1:6

THIS DOCUMENT IS THE PROPERTY OF TREBOR MANUFACTURING. ANY UNAUTHORIZED REPRODUCTION WILL BE PROSECUTED TO THE FULL EXTENT OF THE LAW

UNLESS OTHERWISE SPECIFIED, DIMENSIONS ARE IN INCHES

.XX = ±.1- ANGULAR = ±1°  
.XXX = ±.015- FRACTIONAL = ±1/8  
.XXXX = ±.005-

THIRD ANGLE PROJECTION

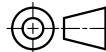

DRAWN SHAWN CROCKER 08/01/2021

MATERIAL 1/8 ALU CHECKER

PART NO. TRTC1872 REV. B

TOP COVER STYLE TOOL BOX - 24 X 18 X 72 - X2 CLICK HANDLE

SIZE A DWG NO. D9130 REV. B

SCALE 1:25 WEIGHT 103.08 LB SHEET 1 of 1