

2

1

B

B

1/8 ALU CHECKER DOOR

1/8 ALU CHECKER BODY

HANDLES ARE LINKED TOGETHER TO ACT IN UNISON

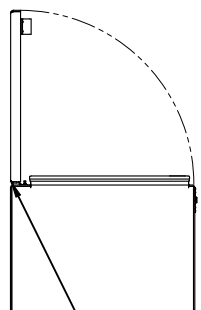
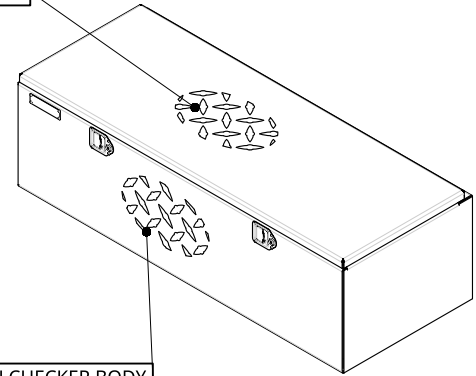
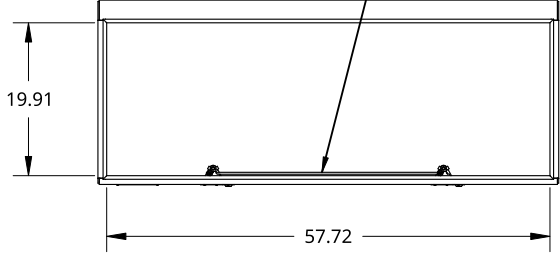

LID IS FLUSH WITH BACK WHEN OPENED TO 90 DEG

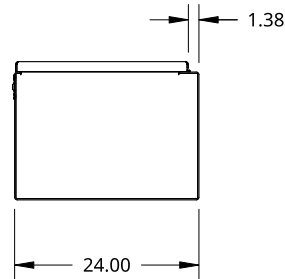
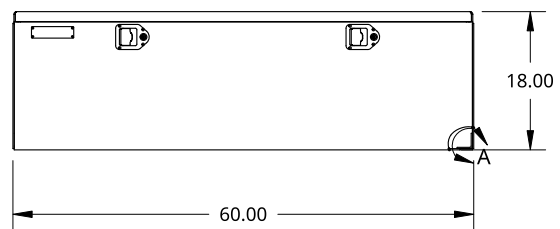

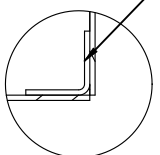

INNER REINFORCEMENT ANGLE BOTH SIDES



DETAIL A SCALE 1:6

A

A

<small>THIS DOCUMENT IS THE PROPERTY OF TREBOR MANUFACTURING. ANY UNAUTHORIZED REPRODUCTION WILL BE PROSECUTED TO THE FULL EXTENT OF THE LAW</small>				PART NO. TRTC1860	REV. B
UNLESS OTHERWISE SPECIFIED, DIMENSIONS ARE IN INCHES .XX = ±.1- .XXX = ±.015- .XXXX = ±.005-		DRAWN BY SHAWN CROCKER CHANGED BY SHAWN CROCKER	08/01/2021 10/21/2024	TOP COVER STYLE TOOL BOX - 24 X 18 X 60 - X2 CLICK HANDLE	
THIRD ANGLE PROJECTION 		MATERIAL 1/8 ALU CHECKER		SIZE A	DWG NO. D9129
				SCALE 1:25	SHEET 1 of 1

2

1