

2

1

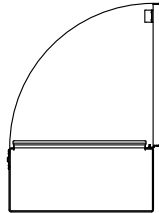
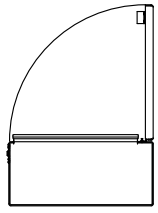

FLUSH OPENING LID
OPTION (SHOWN)

NOT FLUSH OPENING
LID OPTION

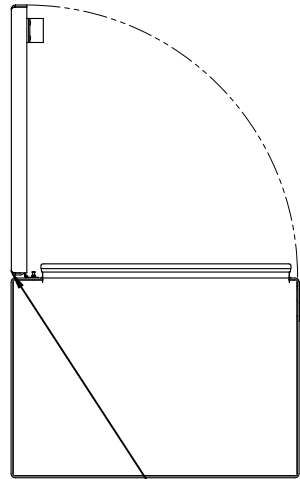
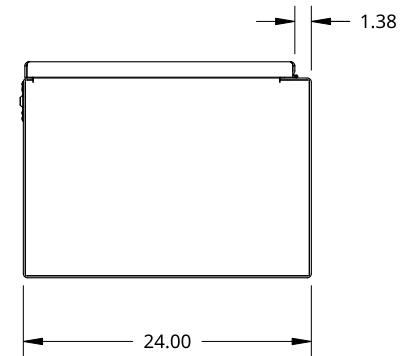
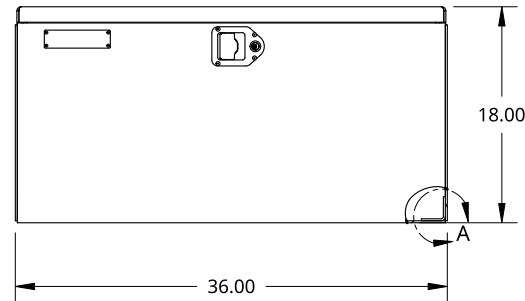
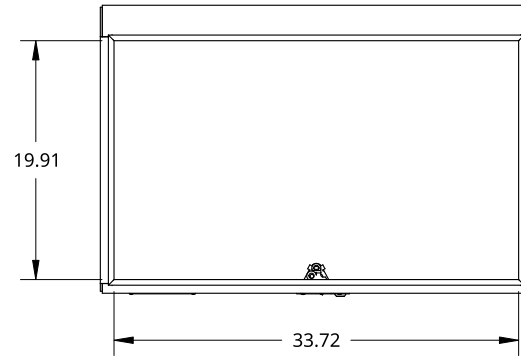
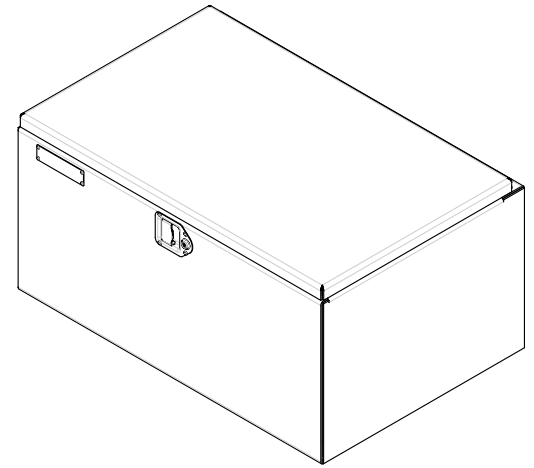

LID IS FLUSH WITH
BACK WHEN
OPENED TO 90 DEG

INNER REINFORCEMENT
ANGLE BOTH SIDES

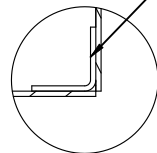

DETAIL A
SCALE 1:6

THIS DOCUMENT IS THE PROPERTY OF TREBOR
MANUFACTURING. ANY UNAUTHORIZED REPRODUCTION
WILL BE PROSECUTED TO THE FULL EXTENT OF THE LAW

UNLESS OTHERWISE SPECIFIED,
DIMENSIONS ARE IN INCHES

.XX = ±.1-
.XXX = ±.015- ANGULAR = ±1°
.XXXX = ±.005- FRACTIONAL = ±1/8

THIRD ANGLE PROJECTION

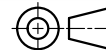

DRAWN SHAWN CROCKER 08/01/2021

MATERIAL
1/8 ALU CHECKER

PART NO. TRTC1836

REV. B

TOP COVER STYLE TOOL BOX - 24 X 18 X 36 - X1 CLICK HANDLE

SIZE A DWG NO. D9127

REV. B

SCALE 1:16 WEIGHT 58.18 LB SHEET 1 of 1

2

1

B

B

A

A