

2

1

B

B

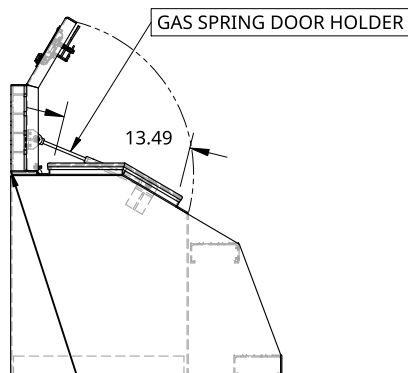
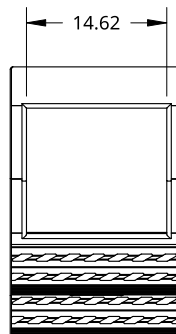
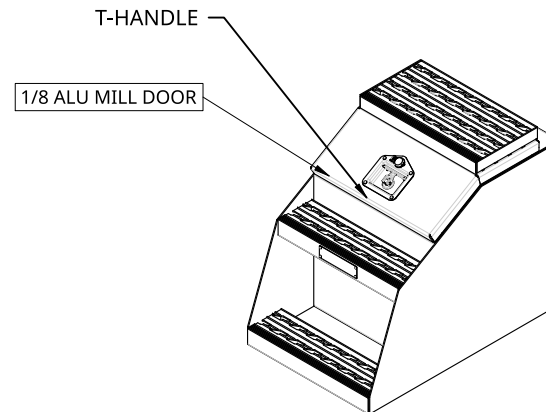

FLUSH WITH BACK OF
BOX WHEN OPEN TO
90 DEG

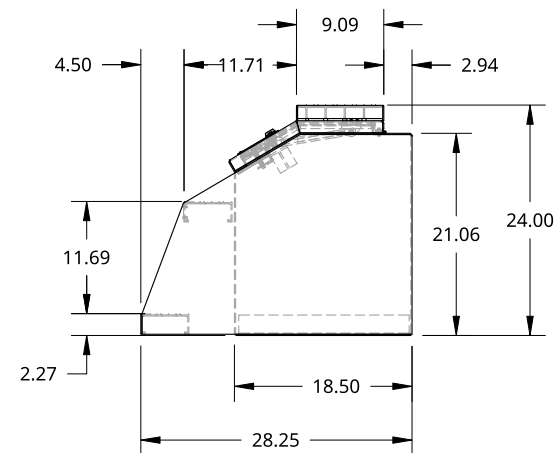
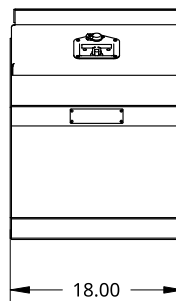

A

A

2

1

THIS DOCUMENT IS THE PROPERTY OF TREBOR
MANUFACTURING. ANY UNAUTHORIZED REPRODUCTION
WILL BE PROSECUTED TO THE FULL EXTENT OF THE LAW

UNLESS OTHERWISE SPECIFIED,
DIMENSIONS ARE IN INCHES

.XX = ±.1-
.XXX = ±.015- ANGULAR = ±1°
.XXXX = ±.005- FRACTIONAL = ±1/8

THIRD ANGLE PROJECTION



DRAWN SHAWN CROCKER 07/15/2021

MATERIAL

1/8 ALU MILL

PART NO. TRSTBPLBM18 REV. A

BIG MOUTH STEP BOX - 28.25 X 24 X 18 - X1 T-HANDLE - 9IN TOP STEP

SIZE A DWG NO. D7946 REV. A1

SCALE 1:20 WEIGHT 43.06 LB SHEET 1 of 1