

2

1

OTHER DOOR OPTIONS

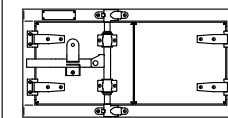

OPEN LEFT

INNER REINFORCEMENT
ANGLE BOTH SIDES

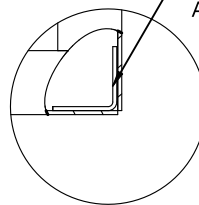

DETAIL B
SCALE 1:6

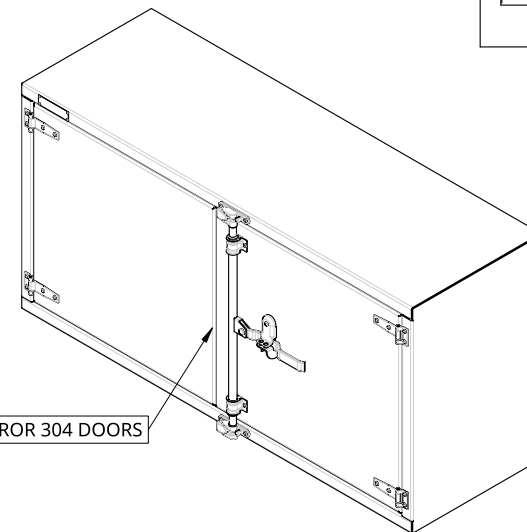

18G SS MIRROR 304 DOORS

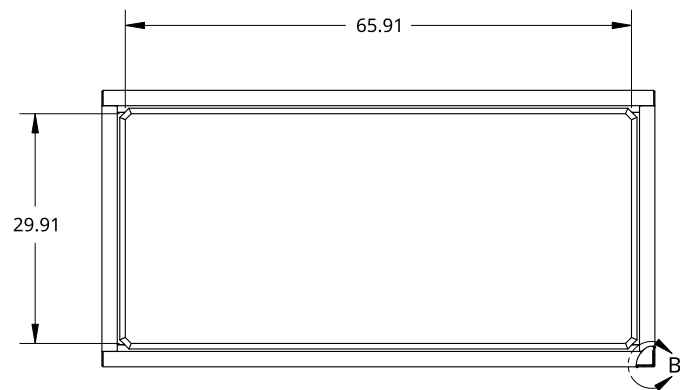

SMALL SIZE TREBOR NAME PLATE

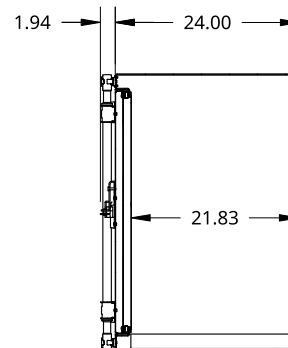
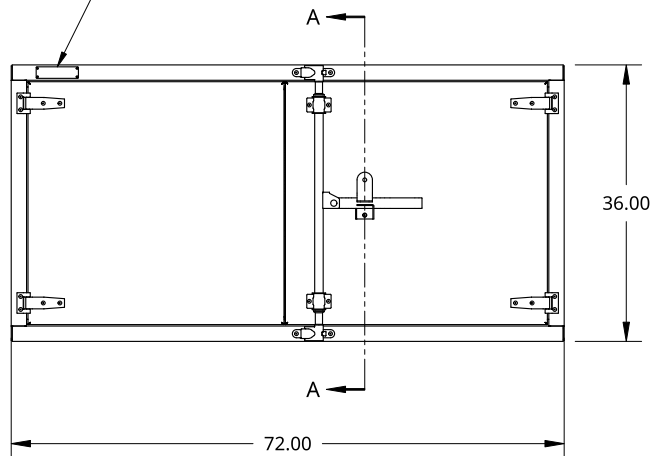

SECTION A - A

THIS DOCUMENT IS THE PROPERTY OF TREBOR
MANUFACTURING. ANY UNAUTHORIZED REPRODUCTION
WILL BE PROSECUTED TO THE FULL EXTENT OF THE LAW

UNLESS OTHERWISE SPECIFIED,
DIMENSIONS ARE IN INCHES

.XX = ±.1-
.XXX = ±.015- ANGULAR = ±1°
.XXXX = ±.005- FRACTIONAL = ±1/8

THIRD ANGLE PROJECTION



DRAWN SHAWN CROCKER 10/13/2021

MATERIAL
1/8 ALU MILL

PART NO. TRPLSS3672P REV. A1

TWO DOOR RECESSED DOOR TOOL BOX - 24 X 36 X 72 - 18G SS MIRROR
DOORS - COMPRESSION LOCK - OPEN RIGHT

SIZE A DWG NO. D6018 REV. A1

SCALE 1:25 WEIGHT 159.79 LB SHEET 1 of 1

2

1

B

A

B

A