

2

1

OTHER DOOR OPTIONS

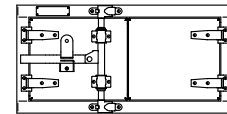

OPEN LEFT

INNER REINFORCEMENT
ANGLE BOTH SIDES

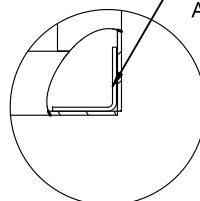

DETAIL B
SCALE 1:6

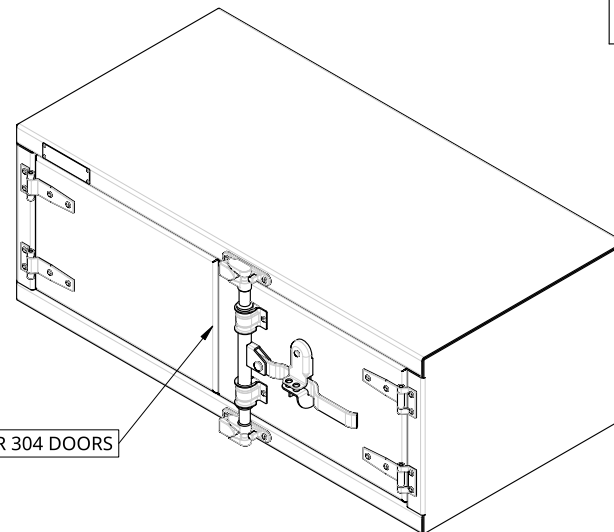
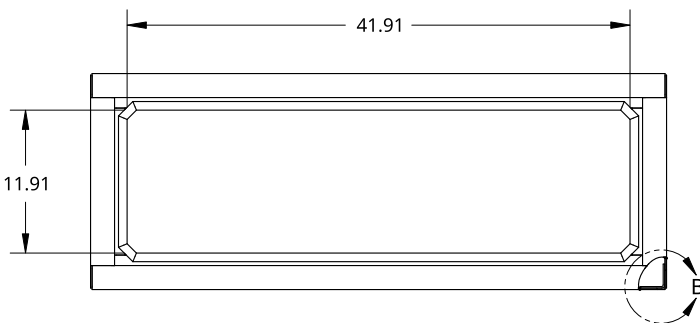

18G SS MIRROR 304 DOORS

SMALL SIZE TREBOR NAME PLATE

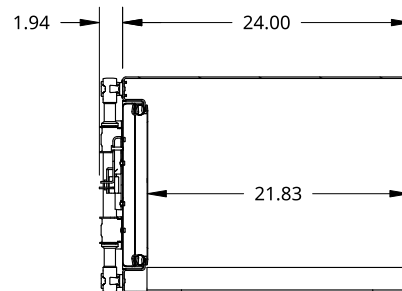
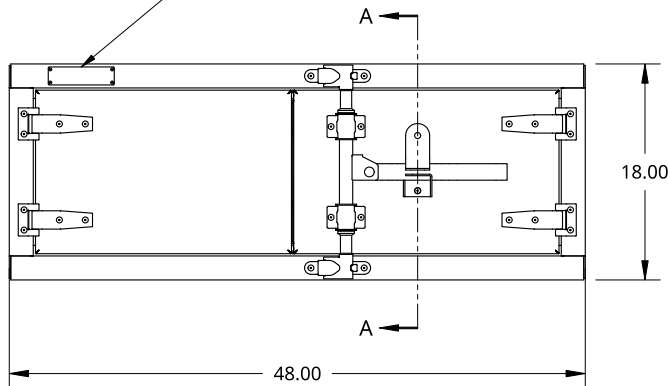

SECTION A - A

THIS DOCUMENT IS THE PROPERTY OF TREBOR
MANUFACTURING. ANY UNAUTHORIZED REPRODUCTION
WILL BE PROSECUTED TO THE FULL EXTENT OF THE LAW

UNLESS OTHERWISE SPECIFIED,
DIMENSIONS ARE IN INCHES

.XX = ±.1-
.XXX = ±.015-
.XXXX = ±.005-
ANGULAR = ±1°
FRACTIONAL = ±1/8

THIRD ANGLE PROJECTION

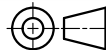

DRAWN SHAWN CROCKER 10/13/2021

MATERIAL

1/8 ALU MILL

PART NO. TRPLSS1848P REV. A1

TWO DOOR RECESSED DOOR TOOL BOX - 24 X 18 X 48 - 18G SS MIRROR
DOORS - COMPRESSION LOCK - OPEN RIGHT

SIZE A DWG NO. D5572 REV. A1

SCALE 1:16 WEIGHT 79.48 LB SHEET 1 of 1

2

1

B

A

B

A