

2

1

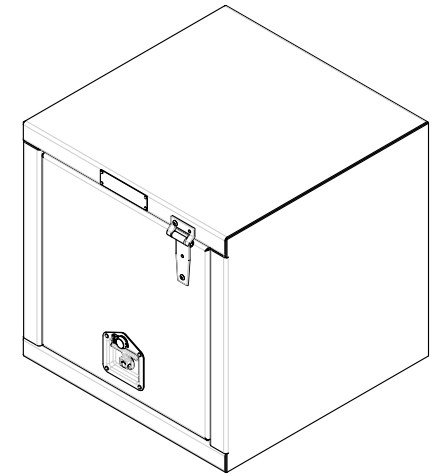

SMALL SIZE TREBOR NAME PLATE

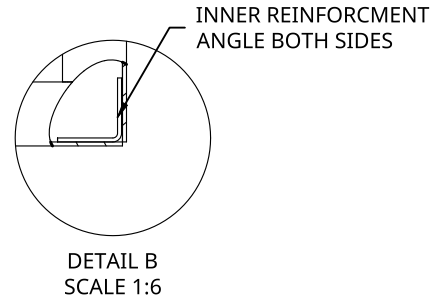
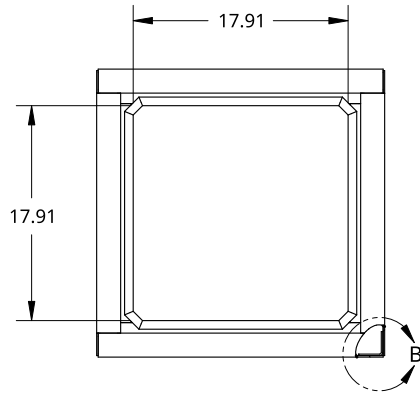
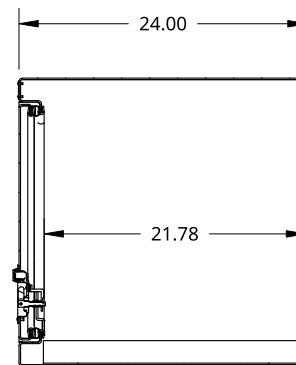
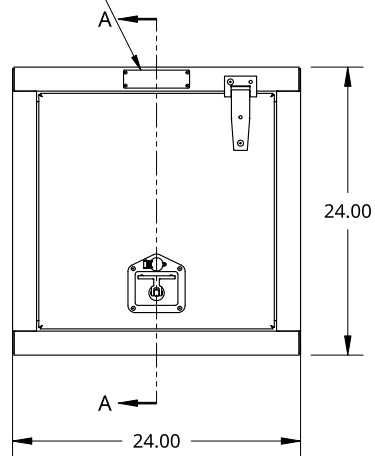

SECTION A - A

THIS DOCUMENT IS THE PROPERTY OF TREBOR MANUFACTURING. ANY UNAUTHORIZED REPRODUCTION WILL BE PROSECUTED TO THE FULL EXTENT OF THE LAW

UNLESS OTHERWISE SPECIFIED, DIMENSIONS ARE IN INCHES

.XX = ±.1-
.XXX = ±.015- ANGULAR = ±1°
.XXXX = ±.005- FRACTIONAL = ±1/8

THIRD ANGLE PROJECTION

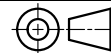

DRAWN SHAWN CROCKER 10/17/2021

MATERIAL

1/8 ALU MILL

PART NO. TRIDPL2424U REV. A

ONE DOOR RECESSED DOOR TOOL BOX - 24 X 24 X 24 - X1 T-HANDLE - OPEN UP

SIZE A DWG. NO. D12442 REV. A

SCALE 1:16 WEIGHT 51.25 LB SHEET 1 of 1

2

1

B

B

A

A