

2

1

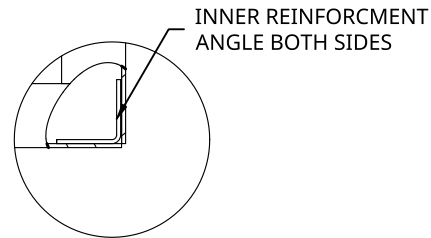
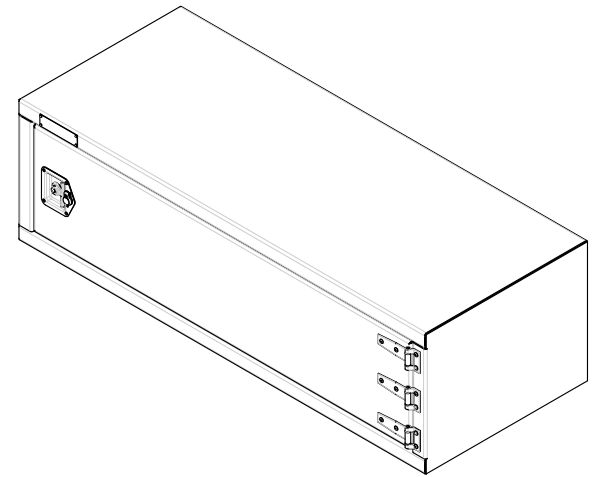

INNER REINFORCEMENT
ANGLE BOTH SIDES

DETAIL B
SCALE 1:6

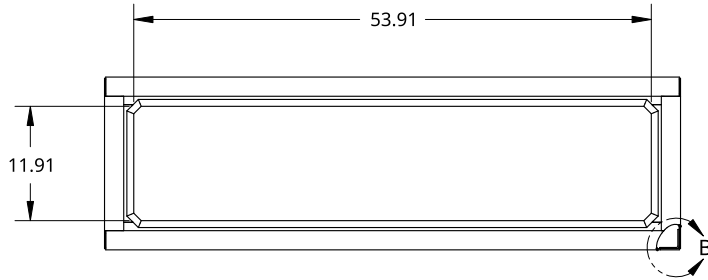

B

SMALL SIZE TREBOR NAME PLATE

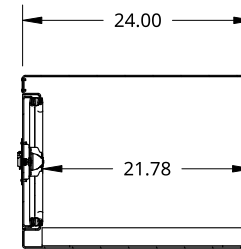
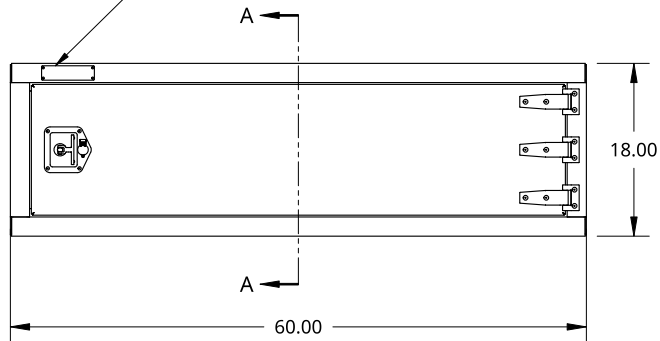

SECTION A - A

A

THIS DOCUMENT IS THE PROPERTY OF TREBOR
MANUFACTURING. ANY UNAUTHORIZED REPRODUCTION
WILL BE PROSECUTED TO THE FULL EXTENT OF THE LAW

UNLESS OTHERWISE SPECIFIED,
DIMENSIONS ARE IN INCHES

.XX = ±.1- ANGULAR = ±1°
.XXX = ±.015- FRACTIONAL = ±1/8
.XXXX = ±.005-

THIRD ANGLE PROJECTION

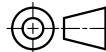

DRAWN SHAWN CROCKER 10/17/2021

MATERIAL

1/8 ALU MILL

PART NO. TRIDPL1860R REV. A

ONE DOOR RECESSED DOOR TOOL BOX - 24 X 18 X 60 - X1 T-HANDLE - X3 HINGES - OPEN RIGHT

SIZE A DWG NO. D12466 REV. A

SCALE 1:20 WEIGHT 86.89 LB SHEET 1 of 1

2

1

B

A