

2

1

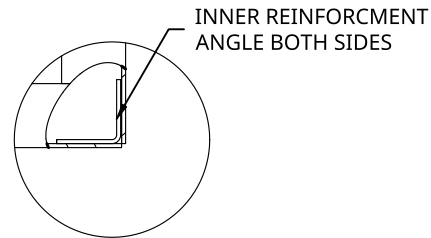
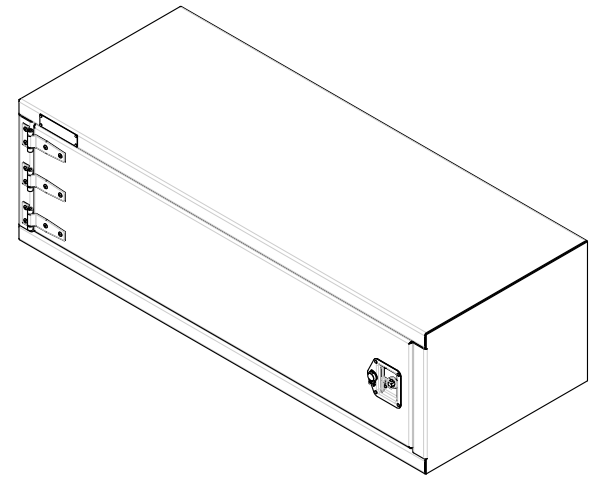

DETAIL B
SCALE 1:6

INNER REINFORCEMENT
ANGLE BOTH SIDES

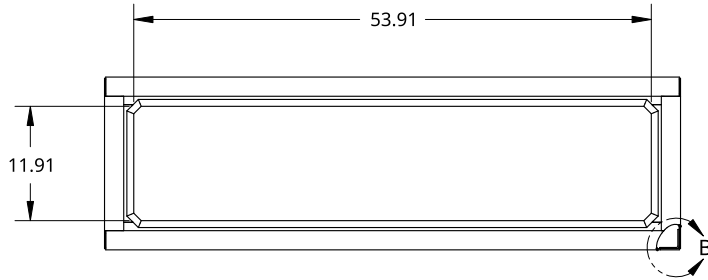

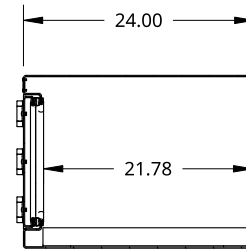
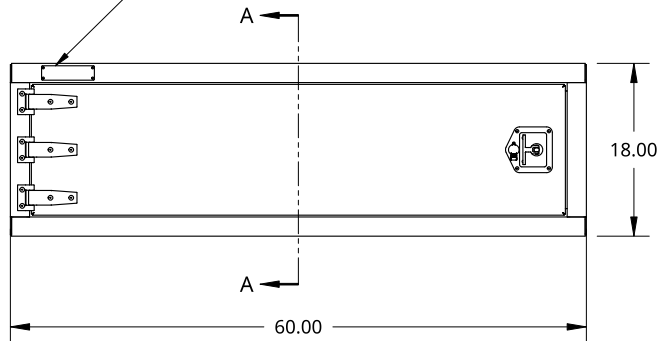

SMALL SIZE TREBOR NAME PLATE



SECTION A - A

B

A

| | | | | | |
|---|--|---|------------------------|--|------------------------|
| <small>THIS DOCUMENT IS THE PROPERTY OF TREBOR MANUFACTURING. ANY UNAUTHORIZED REPRODUCTION WILL BE PROSECUTED TO THE FULL EXTENT OF THE LAW</small> | |  | | PART NO. TRIDPL1860L | REV. A |
| <small>UNLESS OTHERWISE SPECIFIED, DIMENSIONS ARE IN INCHES .XX = ±.1- .XXX = ±.015- .XXXX = ±.005- ANGULAR = ±1° FRACTIONAL = ±1/8</small> | | DRAWN SHAWN CROCKER | 10/17/2021 | ONE DOOR RECESSED DOOR TOOL BOX - 24 X 18 X 60 - X1 T-HANDLE - X3 HINGES - OPEN LEFT | |
| THIRD ANGLE PROJECTION  | | MATERIAL 1/8 ALU MILL | | SIZE A | DWG. NO. D12435 |
| | | SCALE 1:20 | WEIGHT 86.89 LB | SHEET 1 of 1 | REV. A |

2

1

A