

2

1

B

B

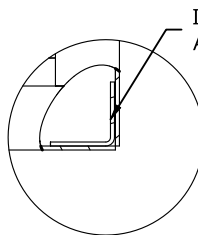
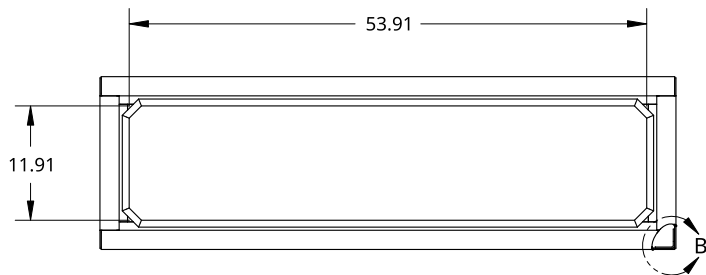

DETAIL B
SCALE 1:6

INNER REINFORCEMENT
ANGLE BOTH SIDES

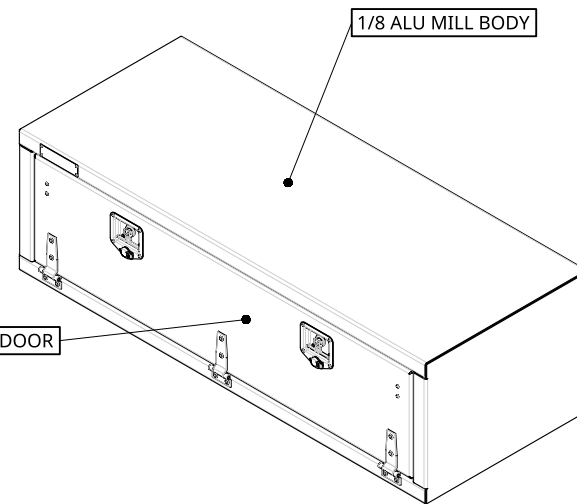

X2 DOOR CHAIN TO HOLD
DOOR AT 90 DEG.

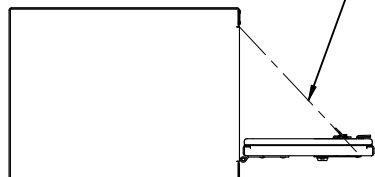

SMALL SIZE TREBOR NAME PLATE

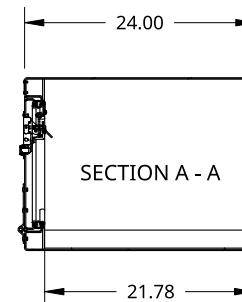
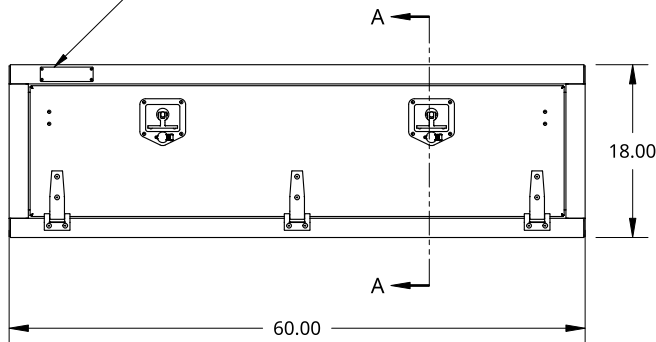

SECTION A - A

A

A

THIS DOCUMENT IS THE PROPERTY OF TREBOR
MANUFACTURING. ANY UNAUTHORIZED REPRODUCTION
WILL BE PROSECUTED TO THE FULL EXTENT OF THE LAW



PART NO. TRIDPL1860 REV. B

UNLESS OTHERWISE SPECIFIED,
DIMENSIONS ARE IN INCHES

.XX = ±.1-
.XXX = ±.015- ANGULAR = ±1°
.XXXX = ±.005- FRACTIONAL = ±1/8

DRAWN BY	SHAWN CROCKER	08/03/2021
CHANGED BY	TOMMY HOULE	10/21/2024

ONE DOOR RECESSED DOOR TOOL BOX - 24 X 18 X 60 - X2 T-HANDLES -
X3 HINGES - OPEN DOWN

THIRD ANGLE PROJECTION

MATERIAL

SIZE A DWG NO. D9593 REV. B1

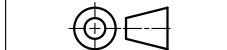

1/8 ALU MILL

SCALE 1:20	WEIGHT 86.89 LB	SHEET 1 of 1
------------	-----------------	--------------

2

1