

2

1

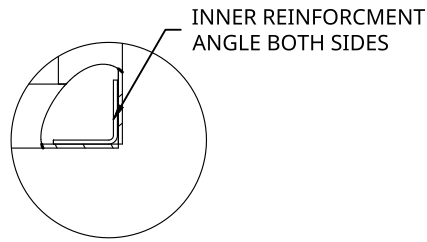

DETAIL B
SCALE 1:6

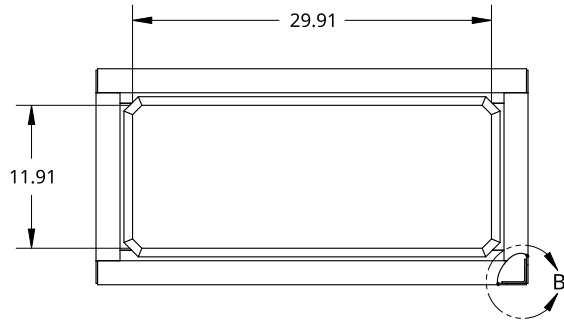
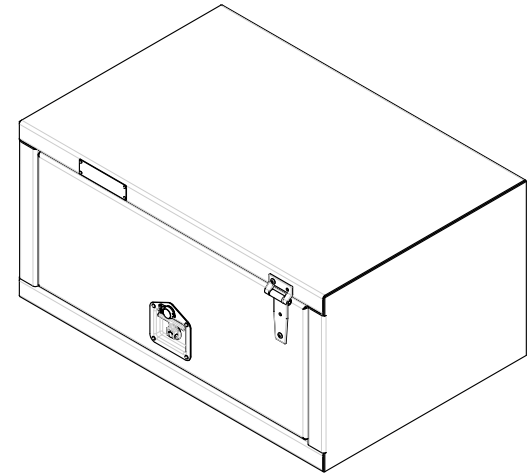

B

SMALL SIZE TREBOR NAME PLATE

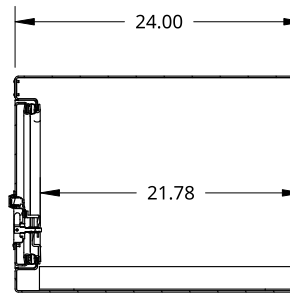
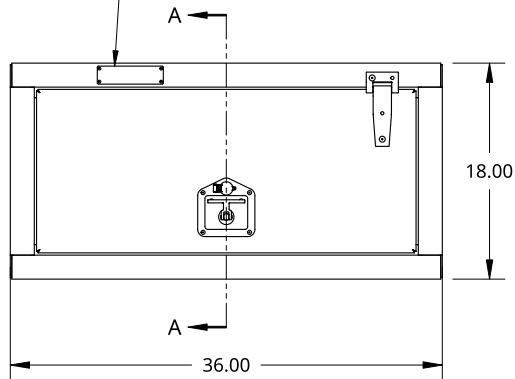

SECTION A - A

A

THIS DOCUMENT IS THE PROPERTY OF TREBOR MANUFACTURING. ANY UNAUTHORIZED REPRODUCTION WILL BE PROSECUTED TO THE FULL EXTENT OF THE LAW

UNLESS OTHERWISE SPECIFIED, DIMENSIONS ARE IN INCHES

.XX = ±.1-
.XXX = ±.015- ANGULAR = ±1°
.XXXX = ±.005- FRACTIONAL = ±1/8

THIRD ANGLE PROJECTION

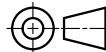

DRAWN SHAWN CROCKER 10/17/2021

MATERIAL
1/8 ALU MILL

PART NO. TRIDPL1836U REV. A

ONE DOOR RECESSED DOOR TOOL BOX - 24 X 18 X 36 - X1 T-HANDLE - OPEN UP

SIZE A DWG. NO. D12431 REV. A

SCALE 1:16 WEIGHT 57.3 LB SHEET 1 of 1

2

1

B

A