

2

1

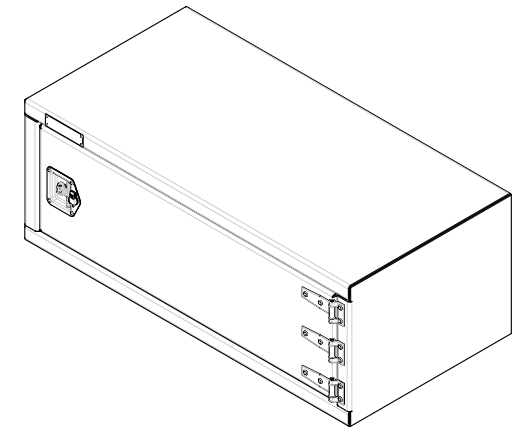

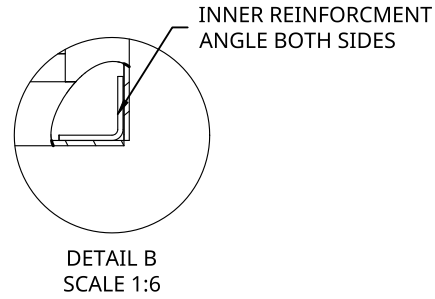
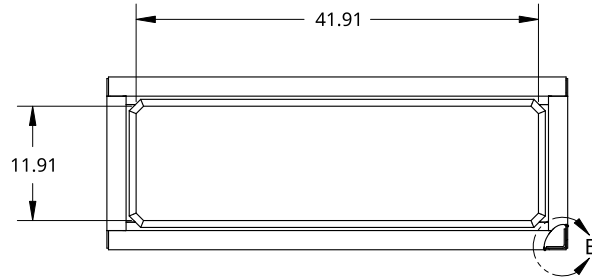

B

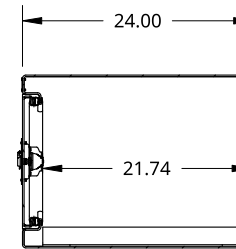
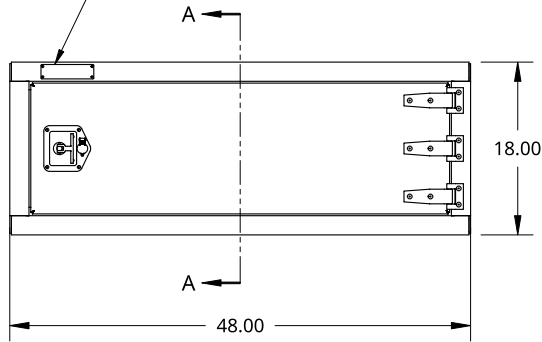
SMALL SIZE TREBOR NAME PLATE



SECTION A - A

A

<small>THIS DOCUMENT IS THE PROPERTY OF TREBOR MANUFACTURING. ANY UNAUTHORIZED REPRODUCTION WILL BE PROSECUTED TO THE FULL EXTENT OF THE LAW</small>				PART NO. <b>TRID1848R</b>	REV. <b>A</b>
UNLESS OTHERWISE SPECIFIED, DIMENSIONS ARE IN INCHES .XX = ±.1- .XXX = ±.015- .XXXX = ±.005-		ANGULAR = ±1° FRACTIONAL = ±1/8		ONE DOOR RECESSED DOOR TOOL BOX - 24 X 18 X 48 - X1 T-HANDLE - X3 HINGES - OPEN RIGHT	
THIRD ANGLE PROJECTION 		MATERIAL <b>1/8 ALU CHECKER</b>		SIZE <b>A</b>	DWG. NO. <b>D12338</b>
		DRAWN SHAWN CROCKER	10/16/2021	SCALE <b>1:20</b>	WEIGHT <b>76.74 LB</b>
				SHEET <b>1 of 1</b>	REV. <b>A</b>

2

1

A