

2

1

B

B

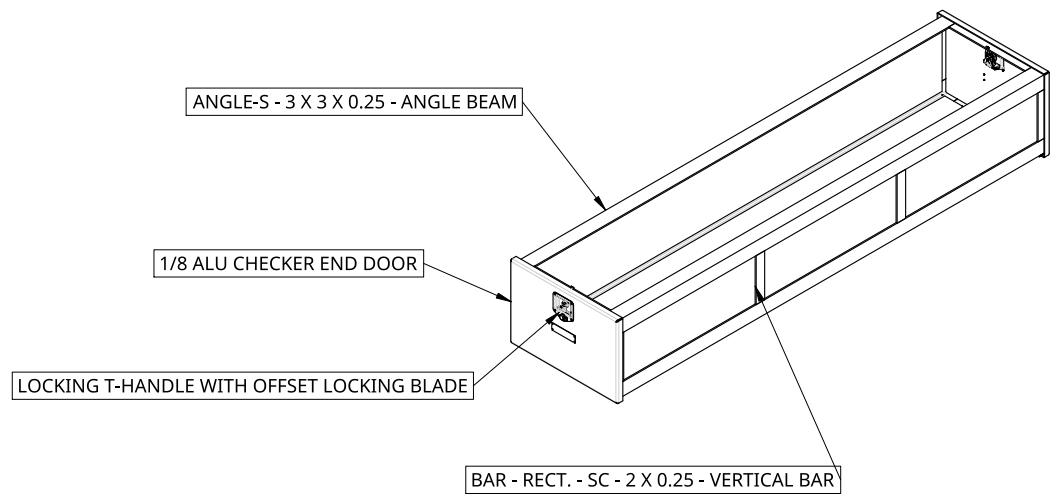
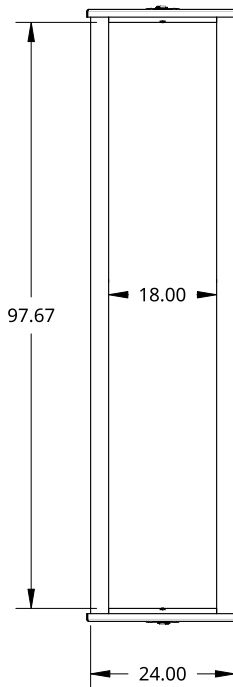

SMALL SIZE TREBOR NAME PLATE

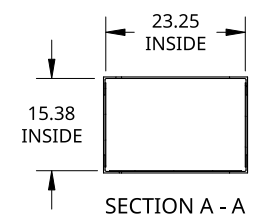
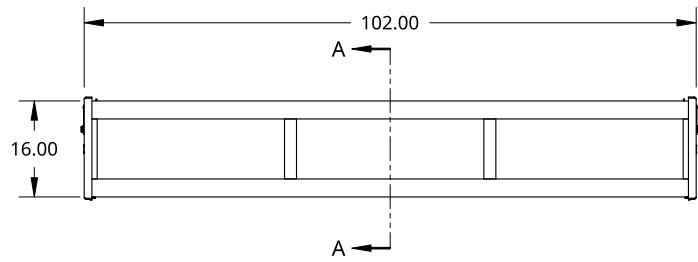
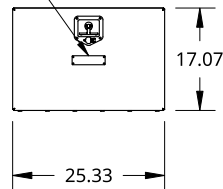
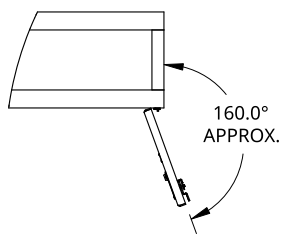

A

A

THIS DOCUMENT IS THE PROPERTY OF TREBOR MANUFACTURING. ANY UNAUTHORIZED REPRODUCTION WILL BE PROSECUTED TO THE FULL EXTENT OF THE LAW

UNLESS OTHERWISE SPECIFIED, DIMENSIONS ARE IN INCHES
 .XX = ±.1-
 .XXX = ±.015-
 .XXXX = ±.005-
 ANGULAR = ±1°
 FRACTIONAL = ±1/8



PART NO. **TRBR1021624MESH** REV. **A**

CROSS FRAME DUNNAGE RACK WITH MESH SIDES - 102 X 16 X 24 - 1/8 ALU CHECKER DOORS - T-HANDLE OPENING DOWN

REVISIONS			
REV.	REVISION DESCRIPTION	DATE APPROVED	APPROVER
A	RELEASED TO MFG	01/25/2022	SHAWN CROCKER

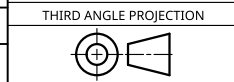

DRAWN SHAWN CROCKER 01/25/2022
 MATERIAL **ALUMINUM**

SIZE A	DWG NO. D15302	REV. A
SCALE 1:32	WEIGHT 146.22 LB	SHEET 1 of 1

2

1