

2

1

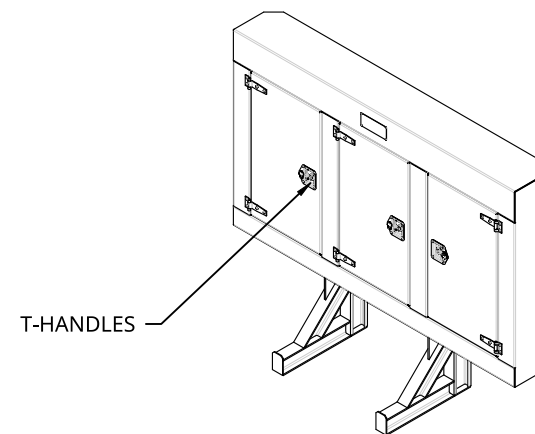
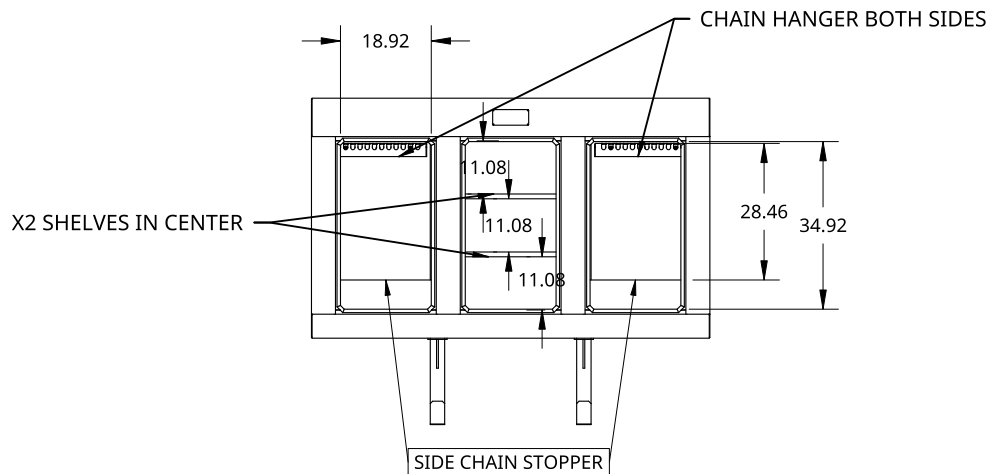

B

B

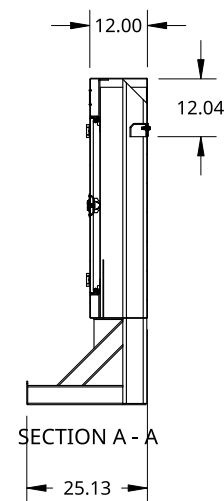
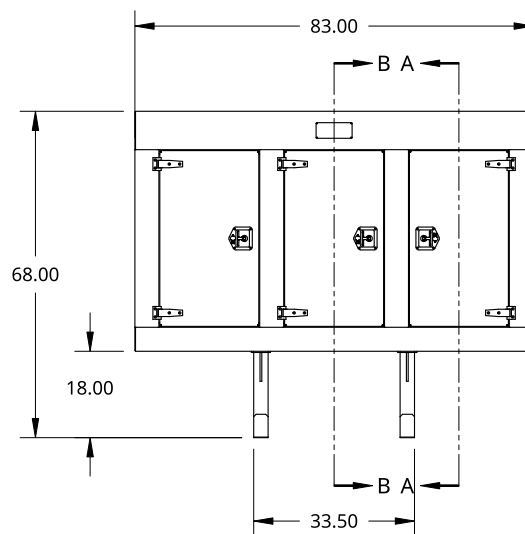
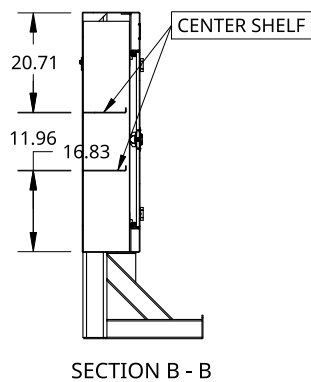

A

A

THIS DOCUMENT IS THE PROPERTY OF TREBOR MANUFACTURING. ANY UNAUTHORIZED REPRODUCTION WILL BE PROSECUTED TO THE FULL EXTENT OF THE LAW

UNLESS OTHERWISE SPECIFIED, DIMENSIONS ARE IN INCHES

.XX = ±.1-
.XXX = ±.015-
.XXXX = ±.005-

ANGULAR = ±1°
FRACTIONAL = ±1/8

THIRD ANGLE PROJECTION



DRAWN SHAWN CROCKER 08/11/2021

MATERIAL 1/8 ALU MILL

PART NO. TR3DPL6883 REV. A

STANDARD COMPARTMENT CAB SHIELD - THREE DOORS - T-HANDLE - 68IN HIGH X 83IN WIDE

SIZE A DWG NO. D10099 REV. A

SCALE 1:40 WEIGHT 283.02 LB SHEET 1 of 1

2

1