

2

1

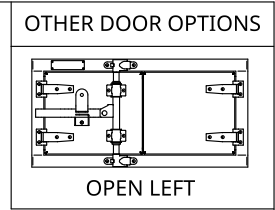

INNER REINFORCEMENT
ANGLE BOTH SIDES

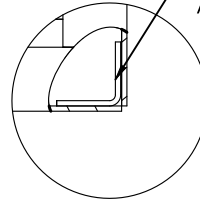

DETAIL B
SCALE 1:6

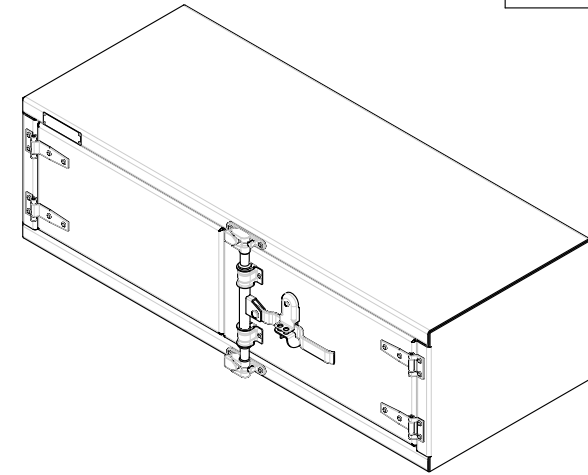
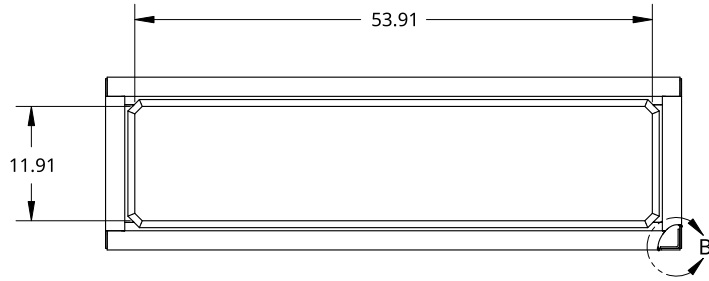

B

SMALL SIZE TREBOR NAME PLATE

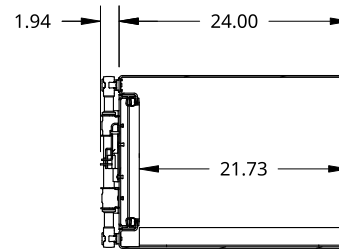
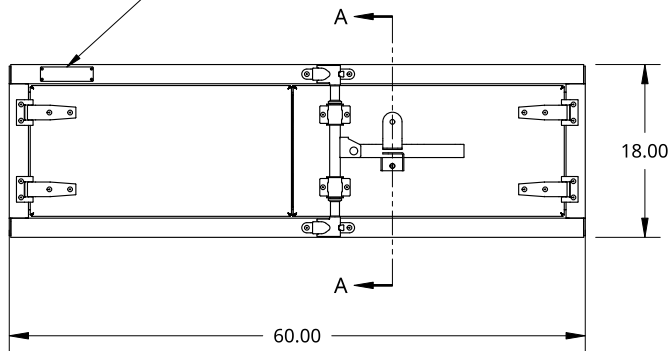

SECTION A - A

A

THIS DOCUMENT IS THE PROPERTY OF TREBOR
MANUFACTURING. ANY UNAUTHORIZED REPRODUCTION
WILL BE PROSECUTED TO THE FULL EXTENT OF THE LAW

UNLESS OTHERWISE SPECIFIED,
DIMENSIONS ARE IN INCHES

.XX = ±.1-
.XXX = ±.015- ANGULAR = ±1°
.XXXX = ±.005- FRACTIONAL = ±1/8

THIRD ANGLE PROJECTION

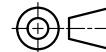

DRAWN SHAWN CROCKER 09/29/2021

MATERIAL
1/8 ALU CHECKER

PART NO. TR1860P REV. A2

TWO DOOR RECESSED DOOR TOOL BOX - 24 X 18 X 60 - COMPRESSION
LOCK - OPEN RIGHT

SIZE A DWG. NO. D4954 REV. A1

SCALE 1:20 WEIGHT 102.08 LB SHEET 1 of 1

2

1