

2

1

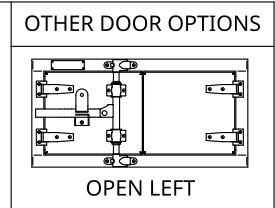

INNER REINFORCEMENT
ANGLE BOTH SIDES

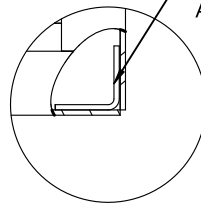

DETAIL B
SCALE 1:6

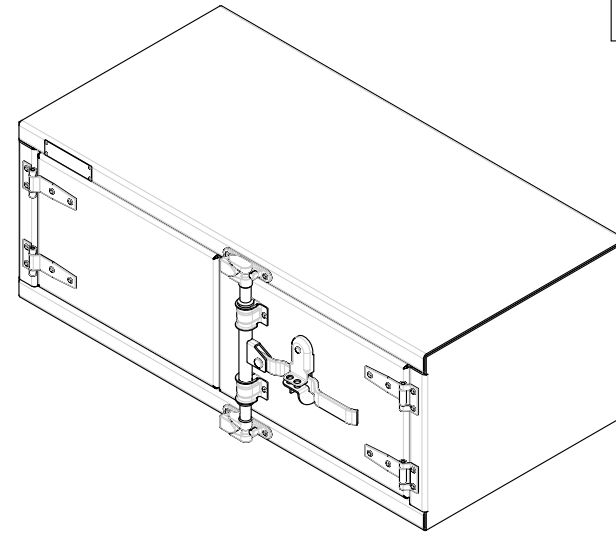
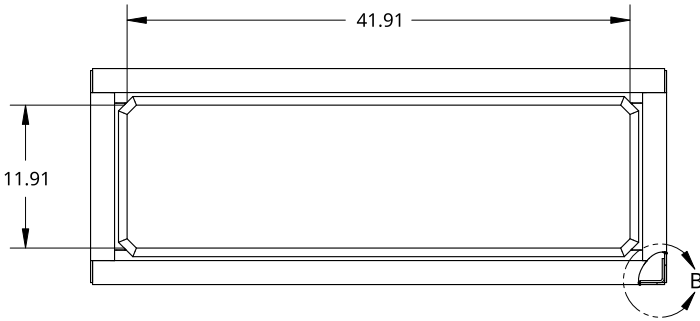

B

SMALL SIZE TREBOR NAME PLATE

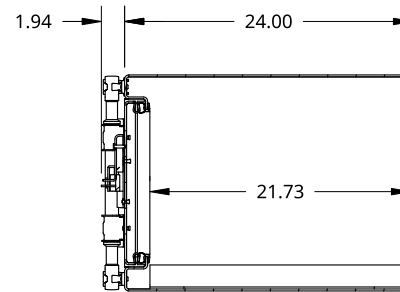
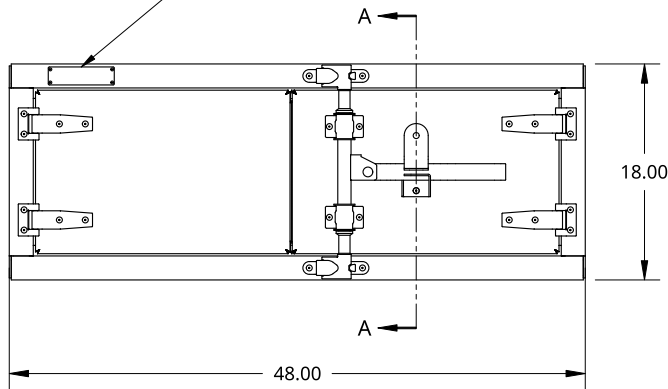

SECTION A - A

A

THIS DOCUMENT IS THE PROPERTY OF TREBOR
MANUFACTURING. ANY UNAUTHORIZED REPRODUCTION
WILL BE PROSECUTED TO THE FULL EXTENT OF THE LAW

UNLESS OTHERWISE SPECIFIED,
DIMENSIONS ARE IN INCHES

.XX = ±.1- ANGULAR = ±1°
.XXX = ±.015- FRACTIONAL = ±1/8
.XXXX = ±.005-

THIRD ANGLE PROJECTION

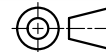

DRAWN SHAWN CROCKER 09/29/2021

MATERIAL
1/8 ALU CHECKER

PART NO. TR1848P REV. A2

TWO DOOR RECESSED DOOR TOOL BOX - 24 X 18 X 48 - COMPRESSION
LOCK - OPEN RIGHT

SIZE A DWG NO. D11985 REV. A

SCALE 1:16 WEIGHT 83.24 LB SHEET 1 of 1

2

1

B

A