

SPECIFICATIONS	
OVERALL LENGTH	96.00 IN
OVERALL WIDTH	101.88 IN
HEADBOARD HEIGHT	48.00 IN
MAIN SILL TYPE	4 X 4 X 0.25 TUBULAR MAIN SILL
MAIN SILL SPREAD	34IN
DRIVERS SIDE WINCHES WITH 3IN STRAPS 5400LB WLL.	X3
2.5IN LED CLEARANCE LIGHTS IN FOUR CORNERS	

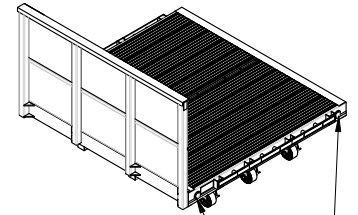

2.5IN CIRCULAR LIGHT - AMBER LENSE AND LIGHT - UNSEALED 2-WIRE PLUG

2.5IN CIRCULAR LIGHT - RED LENSE AND LIGHT - UNSEALED 2-WIRE PLUG

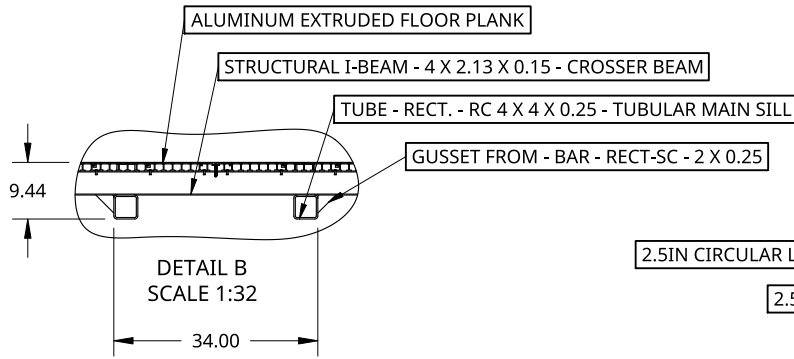
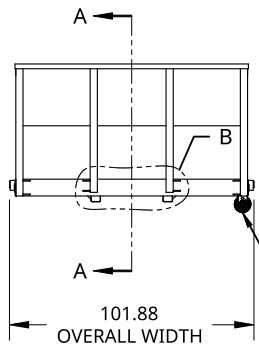

X3 WINCHES AND STRAPS ON DRIVERS SIDE

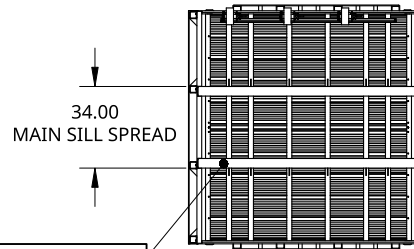
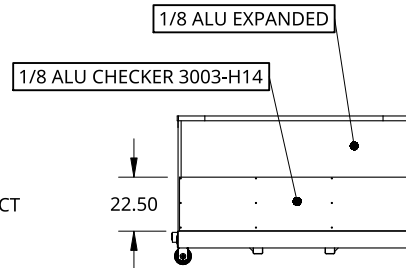
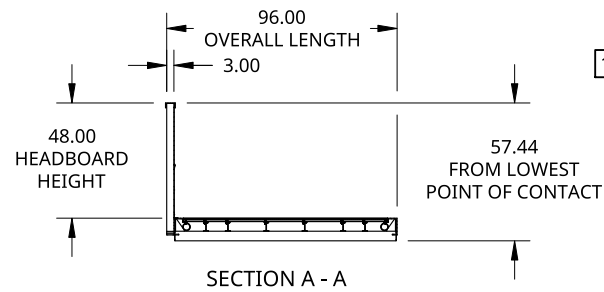

TUBE - RECT. - RC 4 X 4 X 0.25 - TUBULAR MAIN SILL

THIS DOCUMENT IS THE PROPERTY OF TREBOR MANUFACTURING. ANY UNAUTHORIZED REPRODUCTION WILL BE PROSECUTED TO THE FULL EXTENT OF THE LAW



UNLESS OTHERWISE SPECIFIED, DIMENSIONS ARE IN INCHES

.XX = ±.1-
.XXX = ±.015- ANGULAR = ±1°
.XXXX = ±.005- FRACTIONAL = ±1/8

THIRD ANGLE PROJECTION

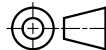

MATERIAL

ALU 6061-T6

PART NO.		PFSUB8		REV.	A
FLAT DECK TRUCK BODY WITH POCKETS AND 4X4 TUBE MAIN SILL - 96IN LONG OVERALL X 102IN WIDE - 48IN HIGH HEADBOARD - X3 WINCHES AND STRAPS ON DRIVERS SIDE					
SIZE	A	DWG NO.	D22860		REV.
SCALE	1:80	WEIGHT	743.75 LB	SHEET	1 of 1