

SPECIFICATIONS	
OVERALL LENGTH	228.00 IN
OVERALL WIDTH	101.88 IN
HEADBOARD HEIGHT	60.00 IN
MAIN SILL TYPE	4 X 4 X 0.25 TUBULAR MAIN SILL
MAIN SILL SPREAD	34IN
DRIVERS SIDE WINCHES WITH 3IN STRAPS 5400LB WLL.	X5
TOP OF DECK MOUNTED TAILBOARD (SHIPPED UNINSTALLED)	24IN HIGH
DECK SIDE ACCESS LADDERS (SHIPPED UNINSTALLED)	X2
GRAB HANDLES ON BOTH SIDES OF HEADBOARD	
2.5IN LED CLEARANCE LIGHTS IN FOUR CORNERS	

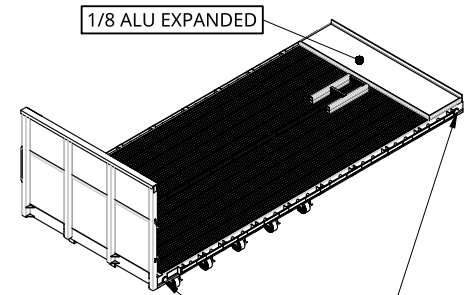
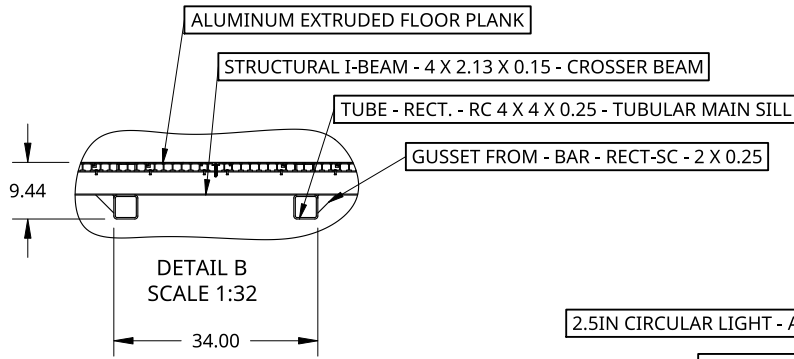

2.5IN CIRCULAR LIGHT - AMBER LENSE AND LIGHT - UNSEALED 2-WIRE PLUG

2.5IN CIRCULAR LIGHT - RED LENSE AND LIGHT - UNSEALED 2-WIRE PLUG

TUBULAR GRAB HANDLE - 28IN

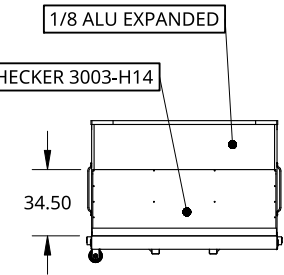
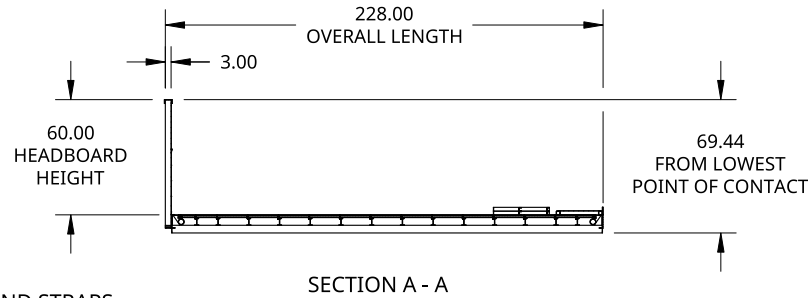
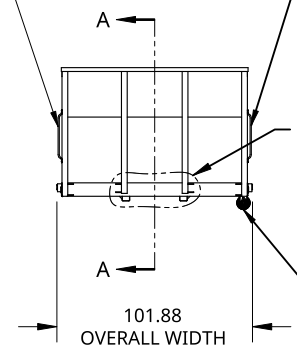

X5 WINCHES AND STRAPS ON DRIVERS SIDE

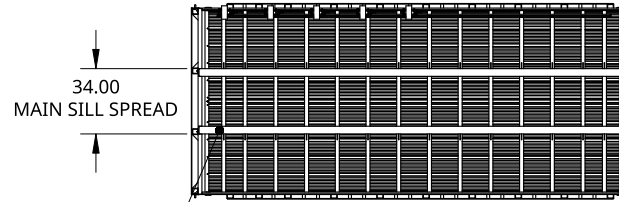

TUBE - RECT. - RC 4 X 4 X 0.25 - TUBULAR MAIN SILL

THIS DOCUMENT IS THE PROPERTY OF TREBOR MANUFACTURING. ANY UNAUTHORIZED REPRODUCTION WILL BE PROSECUTED TO THE FULL EXTENT OF THE LAW



UNLESS OTHERWISE SPECIFIED, DIMENSIONS ARE IN INCHES  
 .XX = ±.1-  
 .XXX = ±.015- ANGULAR = ±1°  
 .XXXX = ±.005- FRACTIONAL = ±1/8

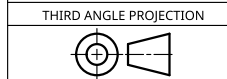

DRAWN BY SHAWN CROCKER 11/01/2022  
 CHANGED BY SHAWN CROCKER 11/04/2022

MATERIAL  
 ALU 6061-T6

PART NO. PFSUB19		REV. A
FLAT DECK TRUCK BODY WITH POCKETS AND 4X4 TUBE MAIN SILL - 228IN LONG OVERALL X 102IN WIDE - 48IN HIGH HEADBOARD - X5 WINCHES AND STRAPS ON DRIVERS SIDE		
SIZE A	DWG NO. D23210	REV. A
SCALE 1:100	WEIGHT 1593.31 LB	SHEET 1 of 1