

SPECIFICATIONS	
OVERALL LENGTH	96.00 IN
OVERALL WIDTH	101.88 IN
HEADBOARD HEIGHT	48.00 IN
MAIN SILL TYPE	3 X 4 X 0.38 ANGLE SILL
MAIN SILL SPREAD	35.50 IN (INSIDE ANGLE)
DRIVERS SIDE WINCHES WITH 3IN STRAPS 5400LB WLL.	X3
2.5IN LED CLEARANCE LIGHTS IN FOUR CORNERS	

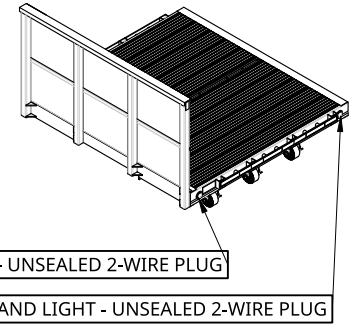

2.5IN CIRCULAR LIGHT - AMBER LENSE AND LIGHT - UNSEALED 2-WIRE PLUG

2.5IN CIRCULAR LIGHT - RED LENSE AND LIGHT - UNSEALED 2-WIRE PLUG

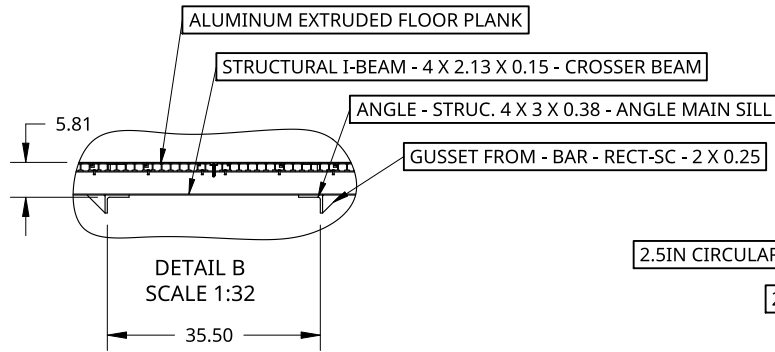
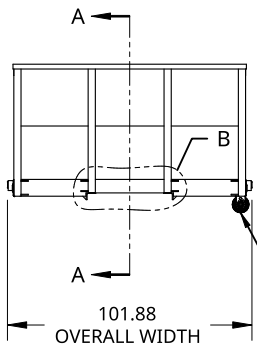

X3 WINCHES AND STRAPS ON DRIVERS SIDE

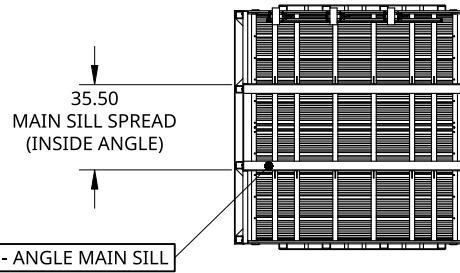
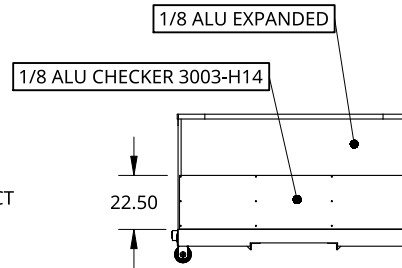
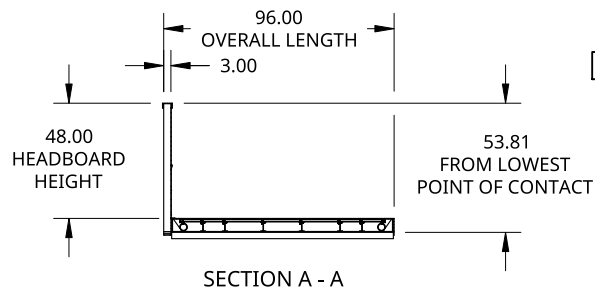

THIS DOCUMENT IS THE PROPERTY OF TREBOR MANUFACTURING. ANY UNAUTHORIZED REPRODUCTION WILL BE PROSECUTED TO THE FULL EXTENT OF THE LAW

UNLESS OTHERWISE SPECIFIED, DIMENSIONS ARE IN INCHES

.XX = ±.1-
.XXX = ±.015- ANGULAR = ±1°
.XXXX = ±.005- FRACTIONAL = ±1/8

THIRD ANGLE PROJECTION

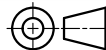

DRAWN BY	SHAWN CROCKER	11/01/2022
CHANGED BY	SHAWN CROCKER	11/02/2022

MATERIAL
ALU 6061-T6

PART NO. PFAGL8 REV. A

FLAT DECK TRUCK BODY WITH POCKETS AND ANGLE MAIN SILL - 96IN LONG OVERALL X 102IN WIDE - 48IN HIGH HEADBOARD - X3 WINCHES AND STRAPS ON DRIVERS SIDE

SIZE A DWG NO. D22861 REV. A

SCALE 1:80	WEIGHT 717.76 LB	SHEET 1 of 1
------------	------------------	--------------