

SPECIFICATIONS	
OVERALL LENGTH	192.00 IN
OVERALL WIDTH	101.88 IN
HEADBOARD HEIGHT	48.00 IN
MAIN SILL TYPE	3 X 4 X 0.38 ANGLE SILL
MAIN SILL SPREAD	35.5IN (INSIDE ANGLE)
DRIVERS SIDE WINCHES WITH 3IN STRAPS 5400LB WLL.	X5
2.5IN LED CLEARANCE LIGHTS IN FOUR CORNERS	

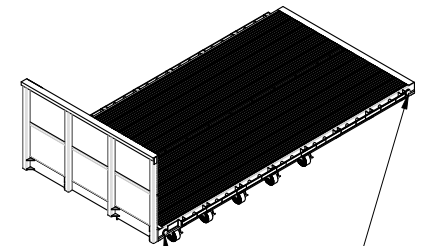

2.5IN CIRCULAR LIGHT - AMBER LENSE AND LIGHT - UNSEALED 2-WIRE PLUG

2.5IN CIRCULAR LIGHT - RED LENSE AND LIGHT - UNSEALED 2-WIRE PLUG

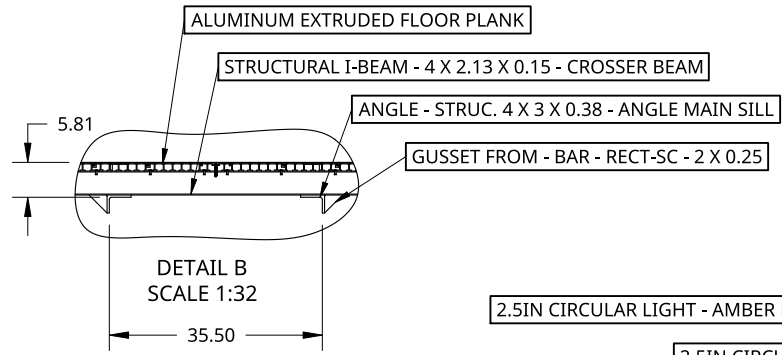
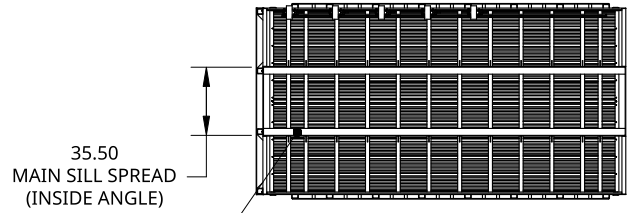
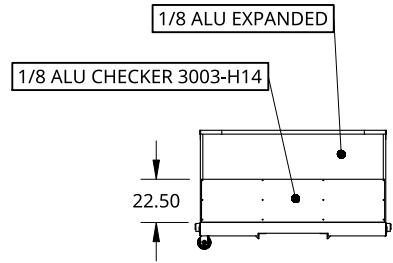
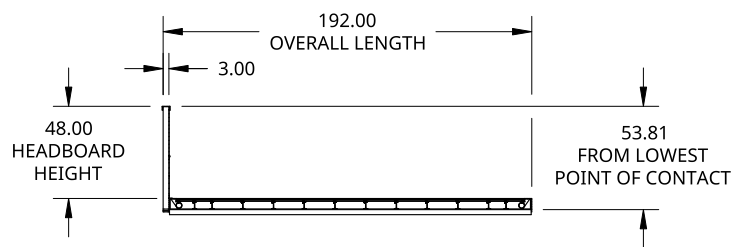
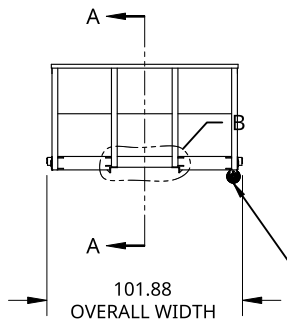

THIS DOCUMENT IS THE PROPERTY OF TREBOR MANUFACTURING. ANY UNAUTHORIZED REPRODUCTION WILL BE PROSECUTED TO THE FULL EXTENT OF THE LAW

UNLESS OTHERWISE SPECIFIED, DIMENSIONS ARE IN INCHES
 .XX = ±.1-
 .XXX = ±.015- ANGULAR = ±1°
 .XXXX = ±.005- FRACTIONAL = ±1/8

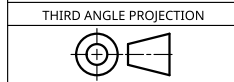

DRAWN BY	SHAWN CROCKER	11/01/2022
CHANGED BY	SHAWN CROCKER	11/10/2022

MATERIAL
 ALU 6061-T6

PART NO. PFAGL16 REV. B

FLAT DECK TRUCK BODY WITH POCKETS AND ANGLE MAIN SILL - 192IN LONG OVERALL X 102IN WIDE - 48IN HIGH HEADBOARD - X5 WINCHES AND STRAPS ON DRIVERS SIDE

SIZE A	DWG NO. D23056	REV. B
SCALE 1:100	WEIGHT 1262.6 LB	SHEET 1 of 1